

# Commande Parking 2 zones 999213

TRCL14 - Schéma de raccordement\Schémas Accessoires\999213-2 Zones\999213.cpj 999213

DOSSIER INFORMATIQUE :	NOM DU DOCUMENT :
------------------------	-------------------

INDICE	DATE	MODIFICATION	VISA
A	15/10/09	Création	NA

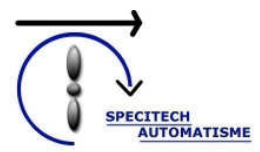

FORUM DES ENTREPRISES  
ROUTE DE CASTELNAUDARY  
31250 REVEL  
TEL : 05.34.66.62.41  
FAX : 05.61.24.93.25

FOLIO	DESIGNATION
4	Raccordement Commda Parking 2 Zones
3	Raccordement AIRONCTROL n°2
2	Raccordement AIRCONTROL n°1
1	PAGE DE GARDE

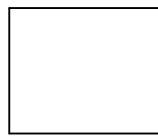

FOLIO  
**1/4**

# Raccordement installateur des bornes de commande du coffret AIRCONTROL N°1

BORNIER DE COMMANDE VERT AIRCONTROL n°1

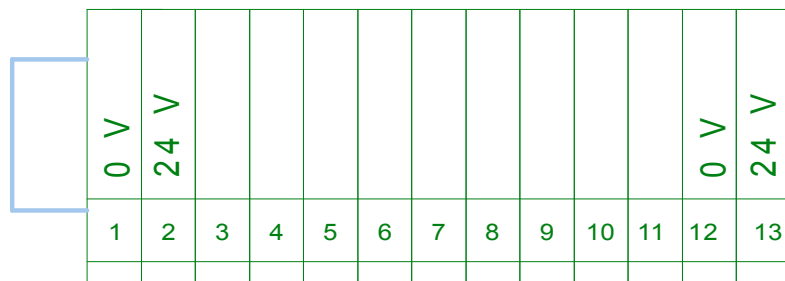

BORNIER DE PUISSANCE AIRCONTROL n°1

CARTE DE COMMANDE AIRCONTROL n°1

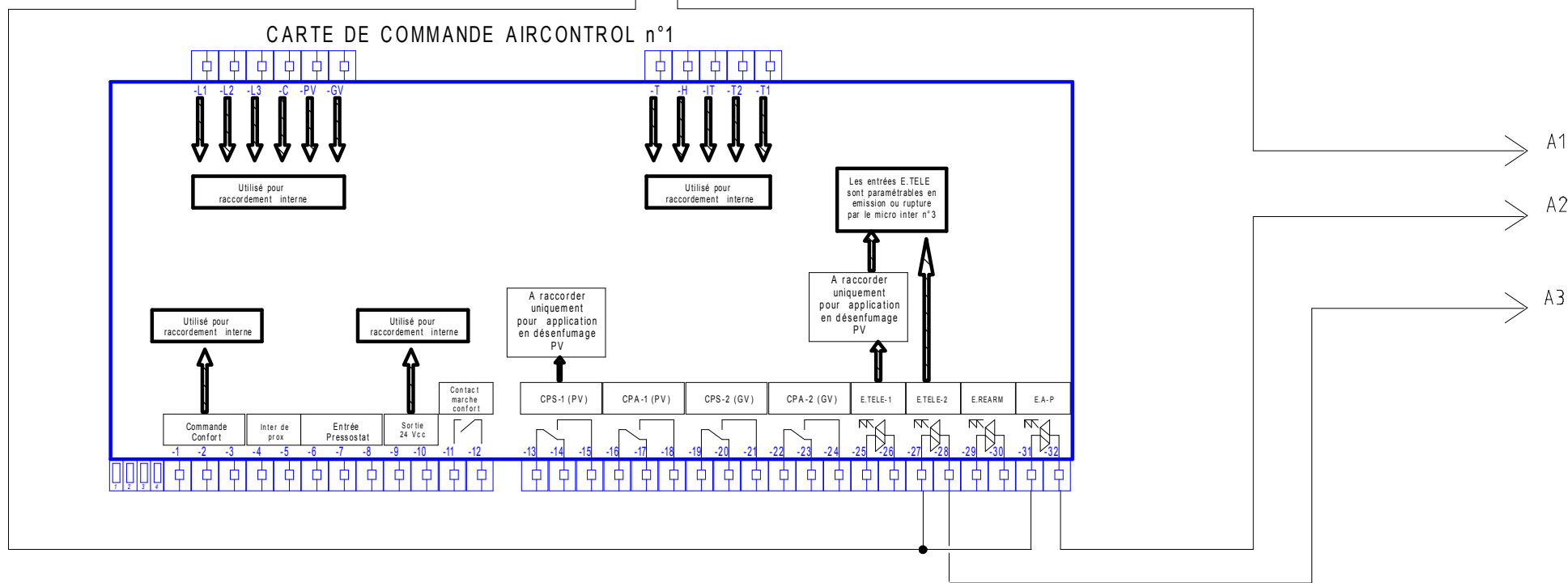

# Raccordement installateur des bornes de commande du coffret AIRCONTROL N°2

BORNIER DE COMMANDE VERT AIRCONTROL n°2

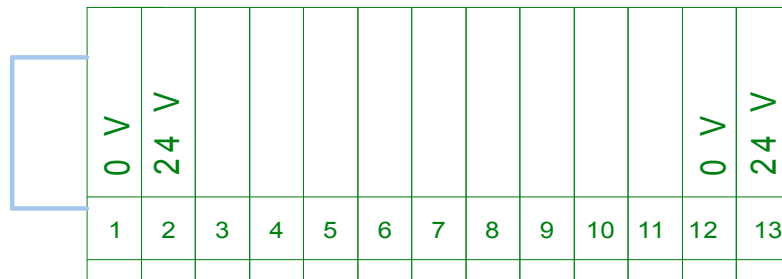

BORNIER DE PUISSANCE AIRCONTROL n°2

CARTE DE COMMANDE AIRCONTROL n°2

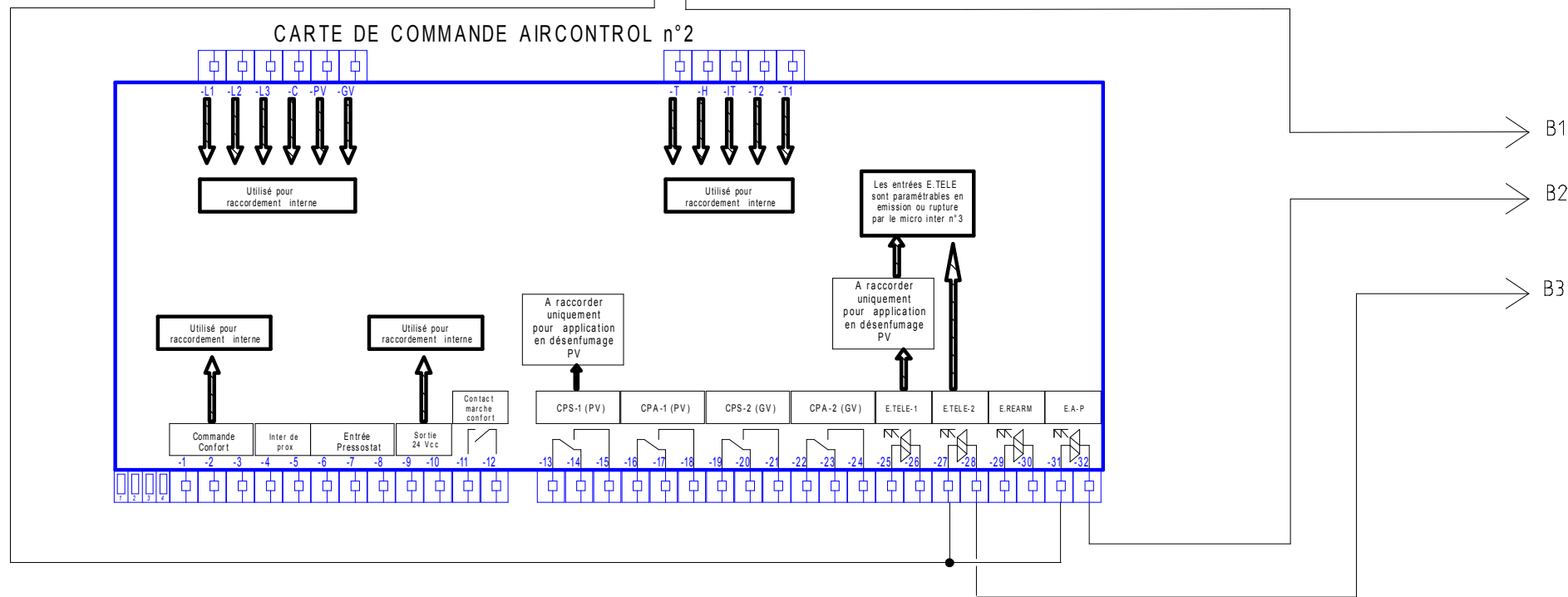

# Raccordement installateur des bornes de commande des 2 coffrets AIRCONTROL sur le boîtier 2 zones

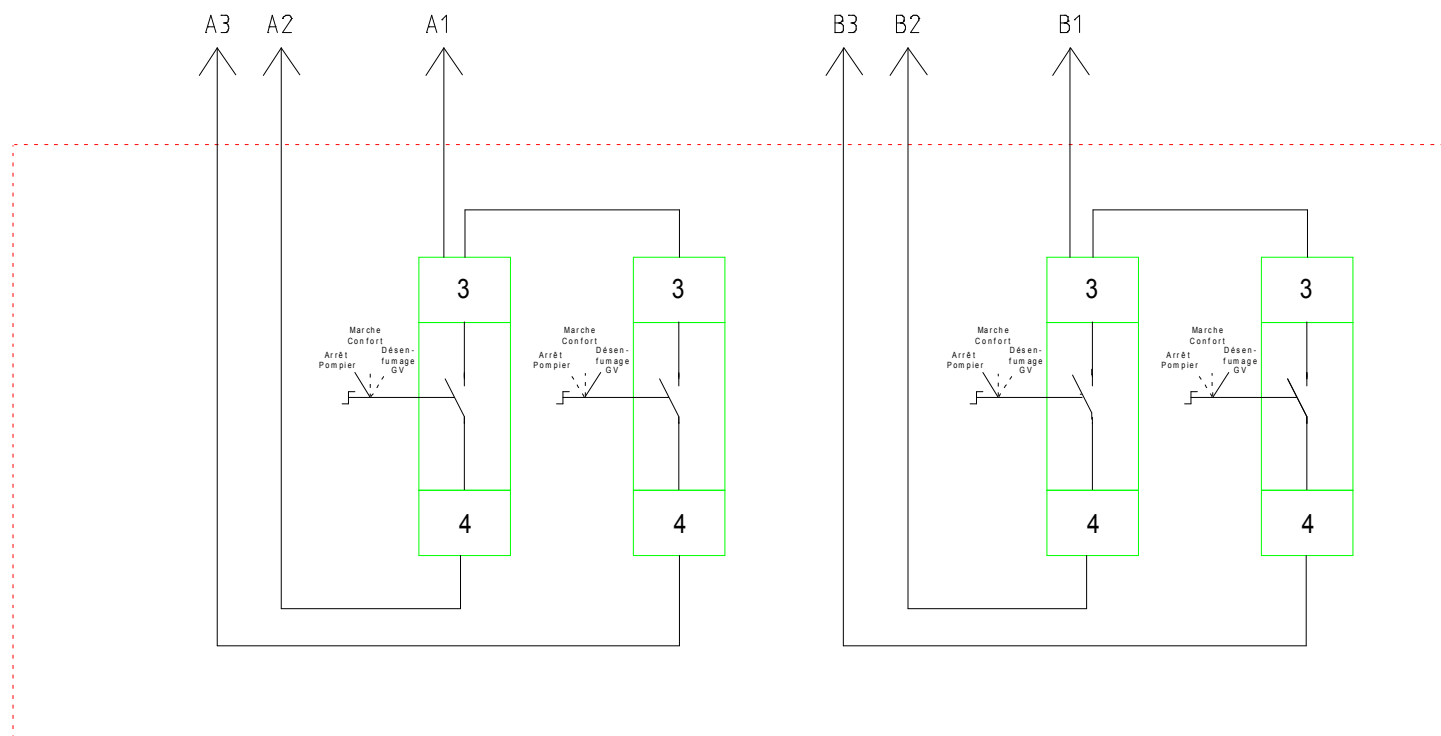

SPECITECH AUTOMATISME  
FORUM DES ENTREPRISES  
ROUTE DE CASTELNAUDARY  
31250 REVEL  
TEL : 05.34.66.62.41  
FAX : 05.61.24.93.25

A	15/10/09	Création	
INDICE	DATE	MODIFICATION	VISA

DOSSIER INFORMATIQUE :  
X:\AIRCONTROL4 - Schéma de raccordement\Schémas Accessoires\999213-2 Zones\999213.cpj  
NOM DU DOCUMENT :  
999213

NOM DU PROJET :  
Commande Parking 2 zones 999213  
Raccordement des 2 coffrets AIRCONTROL sur boîtier 2 Zones